

305 N VICTORY BLVD • BURBANK, CA 91502



SLITTERS

PERFORATORS, SLITTERS & SCORES

TO ORDER:

CALL: 818-846-9134

FAX: 818-846-2090

EMAIL: SALES@LAGRINDING.COM

BAUM..... PAGES 2 - 6

MBO..... PAGES 7 - 13

STAHL..... PAGES 14 - 21

Quick tips on choosing correct blades:

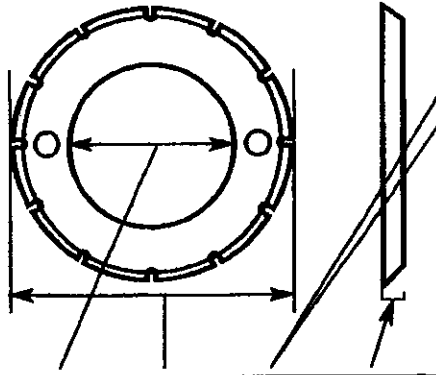

Teeth = Total number of teeth on perf
 # TPI = Number of teeth per inch
 (These are generally referred as micro perfs.)

ID	OD	TEETH	THICK

This guide is organized first by shaft size, smallest to largest.. Then by number of teeth, fewest to most (except micro perfs).

All images in this guide are actual size for comparison.

"V" shaped tooth



- Maximizes the distance between each tooth in perfs with a low number of teeth such as 6, 8, 12 or 18.
- Increases the strength of the teeth in perfs with a high number of teeth such as 60, 72, 80 or more.

Also

If shaft is adjustable, a slightly wider perf cut can be made.

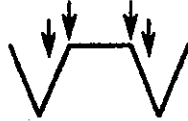

Crimping perf

- Holds sheets together temporarily.
- Used for processing zig zag folded sheets on a gather - stitcher and envelopes on a perfect binder.

Knockout (punch) perf

- Use when printed product needs perforation in the spine for adhesive binding or air relief.

Reverse Tooth

Standard



Reverse



- Assumes blades are placed on upper slitter shaft.
- Holds fold together on 16 page books.

Round Tooth

- Good for perfin multiple sheets at a time.



BAUM* Perforators - 7/8, SHAFT



ID	OD	TEETH	THICK
.880	1.867	6	.062
BAUM # 7618		L.A.G. # SK081136	

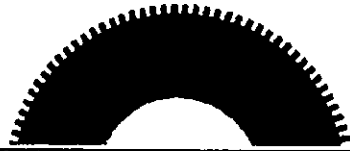

ID	OD	TEETH	THICK
.880	1.867	98	.065
BAUM # 55283		L.A.G. # SK081137	



ID	OD	TEETH	THICK
.880	1.867	12	.062
BAUM # 6605		L.A.G. # SK081133	



ID	OD	TEETH	THICK
.880	1.867	12	.062
BAUM # 15029		L.A.G. # SK081731	



ID	OD	TEETH	THICK
.880	1.867	15	.035
BAUM # 7895		L.A.G. # SK081732	



ID	OD	TEETH	THICK
.880	1.867	18	.035
BAUM # 7896		L.A.G. # SK081733	



ID	OD	TEETH	THICK
.880	1.867	24	.062
BAUM # 7619		L.A.G. # SK081134	



ID	OD	TEETH	THICK
.880	1.867	31	.062
BAUM # 6798		L.A.G. # SK081135	



ID	OD	TEETH	THICK
.880	1.867	41	.035
BAUM # N/A		L.A.G. # SK081130	



ID	OD	TEETH	THICK
.880	1.867	41	.260
BAUM # N/A		L.A.G. # SK081132	

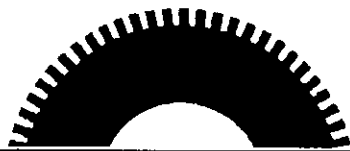

ID	OD	TEETH	THICK
.880	1.867	64	.035
BAUM # 11962		L.A.G. # SK081131	



ID	OD	TEETH	THICK
.880	1.867	72TPI	.065
BAUM # N/A		L.A.G. # SK081734	



ID	OD	TEETH	THICK
1.125	1.900	24	.020
BAUM # 51991		L.A.G. # SK081736	

TO ORDER:

PHONE. 818-846-9134

FAX. 818-846-2090

EMAIL. SALES@LAGRINDING.COM

BAUM* Perforators - 1-1/8, 1-1/4, 1-3/8" SHAFT

1-1/8" SHAFT



ID	OD	TEETH	THICK
1.125	1.900	41	.020
BAUM # 51991-002		L.A.G. # SK081737	



ID	OD	TEETH	THICK
1.125	1.900	64	.020
BAUM # 51991-003		L.A.G. # SK081738	

1-1/4" SHAFT Not Pictured

ID	OD	TEETH	THICK
1.251	1.761	72TPI	.055
BAUM # 263-889-01-00		L.A.G. # SK081739	

1-1/4" SHAFT



ID	OD	TEETH	THICK
1.250	2.062	50	.093
BAUM # ROTO-CRESE		L.A.G. # SK081197	



ID	OD	TEETH	THICK
1.250	2.062	75	.093
BAUM # ROTO-CRESE		L.A.G. # SK081198	

Not Pictured

ID	OD	TEETH	THICK
1.250	2.062	100	.093
BAUM # ROTO-CRESE		L.A.G. # SK081196	

1-3/8" SHAFT



ID	OD	TEETH	THICK
1.375	2.296	12	.063
BAUM # 44706		L.A.G. # SK081745	



ID	OD	TEETH	THICK
1.375	2.296	7	.063
BAUM # 10361		L.A.G. # SK081744	

Not Pictured

ID	OD	TEETH	THICK
1.375	2.296	7	.025
BAUM # 55774		L.A.G. # SK081743	

1-3/8" SHAFT



ID	OD	TEETH	THICK
1.375	2.296	15	.025
BAUM # 55776		L.A.G. # SK081746	



ID	OD	TEETH	THICK
1.375	2.296	15	.025
BAUM # 51940		L.A.G. # SK081143	

Not Pictured

ID	OD	TEETH	THICK
1.375	2.296	15	.025
BAUM # 55777		L.A.G. # SK081747	

1-3/8" SHAFT



ID	OD	TEETH	THICK
1.375	2.296	15	.063
BAUM # 10362		L.A.G. # SK081147	



ID	OD	TEETH	THICK
1.375	2.484	15	.045
BAUM # 16196		L.A.G. # SK081748	



ID	OD	TEETH	THICK
1.375	2.296	15	.062
BAUM # 52393		L.A.G. # SK081749	

TO ORDER:

PHONE. 818-846-9134

FAX. 818-846-2090

EMAIL. SALES@LAGRINDING.COM

BAUM* Perforators - 1-3/8" SHAFT



ID	OD	TEETH	THICK
1.375	2.296	30	.025
BAUM # 51941		L.A.G. # SK081759	



ID	OD	TEETH	THICK
1.375	2.296	30	.063
BAUM # 10363		L.A.G. # SK081144	



ID	OD	TEETH	THICK
1.375	2.296	50	.025
BAUM # 51942		L.A.G. # SK081751	



ID	OD	TEETH	THICK
1.375	2.296	50	.063
BAUM # 10364		L.A.G. # SK081145	



ID	OD	TEETH	THICK
1.375	2.296	86	.063
BAUM # 53425		L.A.G. # SK081146	

TO ORDER:

PHONE. 818-846-9134

FAX. 818-846-2090

EMAIL. SALES@LAGRINDING.COM

BAUM* Slitters & Scores - 7/8, 1-1/8" SHAFT

7/8" SHAFT



ID	OD	TEETH	THICK
.880	1.825		.060
SCORE			
BAUM # N/A		L.A.G. # SK081750	



ID	OD	TEETH	THICK
.880	1.825		.062
SCORE			
BAUM # 6379		L.A.G. # SK081128	



ID	OD	TEETH	THICK
.880	1.875		.062
SCORE			
BAUM # N/A		L.A.G. # SK081764	

7/8" SHAFT



ID	OD	TEETH	THICK
.880	1.850		.125
SCORE - HEAVY			
BAUM # 6380		L.A.G. # SK081138	



ID	OD	TEETH	THICK
.880	1.885		.062
SLITTER - LEFT			
BAUM # 15241		L.A.G. # SK081752	



ID	OD	TEETH	THICK
.880	1.885		.062
SLITTER - RIGHT			
BAUM # 15240		L.A.G. # SK081753	

7/8" SHAFT



ID	OD	TEETH	THICK
.880	1.885		.062
SLITTER			
BAUM # N/A		L.A.G. # SK081754	



ID	OD	TEETH	THICK
.880	1.885		.093
SLITTER - RIGHT			
BAUM # 15573		L.A.G. # SK081755	



ID	OD	TEETH	THICK
.880	1.885		.093
SLITTER - LEFT			
BAUM # 15574		L.A.G. # SK081756	

7/8" SHAFT



ID	OD	TEETH	THICK
.880	1.885		.093
LH - SLITTER			
BAUM # 6804		L.A.G. # SK081140	



ID	OD	TEETH	THICK
.880	1.885		.093
RH - SLITTER			
BAUM # 6378		L.A.G. # SK081141	

1-1/8" SHAFT



ID	OD	TEETH	THICK
1.125	1.519		.062
SLITTER			
BAUM # 92893		L.A.G. # SK081757	

1-1/8" SHAFT



ID	OD	TEETH	THICK
1.125	1.807		.030
SPLIT - SCORE			
BAUM # 51992		L.A.G. # SK081758	



ID	OD	TEETH	THICK
1.125	1.890		.062
SLITTER			
BAUM # CL335		L.A.G. # SK081740	



ID	OD	TEETH	THICK
1.125	1.900		.020
SPLIT - SLITTER			
BAUM # 51989		L.A.G. # SK081741	

TO ORDER:

PHONE. 818-846-9134

FAX. 818-846-2090

EMAIL. SALES@LAGRINDING.COM

BAUM* Slitters & Scores - 1-3/8" SHAFT



ID	OD	TEETH	THICK
1.375	2.228		.030
SCORE			
BAUM # 51947		L.A.G. # SK081742	



ID	OD	TEETH	THICK
1.375	2.275		.063
SCORE			
BAUM # 10352		L.A.G. # SK081142	



ID	OD	TEETH	THICK
1.375	2.296		.025
SLITTER			
BAUM # 51943		L.A.G. # SK081148	



ID	OD	TEETH	THICK
1.375	2.306		.063
SCORE			
BAUM # 10353		L.A.G. # SK081761	



ID	OD	TEETH	THICK
1.375	2.312		.063
SLITTER			
BAUM # 93209		L.A.G. # SK081149	



ID	OD	TEETH	THICK
1.375	2.312		.063
SLITTER			
BAUM # 10348		L.A.G. # SK081762	



ID	OD	TEETH	THICK
1.376	1.906		.012
SPACER			
BAUM # NA-356		L.A.G. # SK081763	

TO ORDER:

PHONE. 818-846-9134

FAX. 818-846-2090

EMAIL. SALES@LAGRINDING.COM

MBO* Slitters & Scores - 30/35mm SHAFT

**30mm
SHAFT**



ID	OD	TEETH	THICK
35MM	54MM	9	1.57MM
MBO #2.0.5591.100		L.A.G. # SK081668	



ID	OD	TEETH	THICK
35MM	53MM	10	0.5MM
MBO #2.0.5591.120		L.A.G. # SK081669	



ID	OD	TEETH	THICK
35MM	53MM	12	0.5MM
MBO #2.0.5591.070		L.A.G. # SK081670	

**30mm
SHAFT**



ID	OD	TEETH	THICK
35MM	53MM	15	0.5MM
MBO #2.0.5591.030		L.A.G. # SK081367	



ID	OD	TEETH	THICK
35MM	53MM	22	0.5MM
MBO #2.0.5591.040		L.A.G. # SK081671	



ID	OD	TEETH	THICK
35MM	53MM	42	0.5MM
MBO #2.0.5591.050		L.A.G. # SK081368	

**30mm
SHAFT**



ID	OD	TEETH	THICK
35MM	54MM	50TPI	0.5MM
MBO # N/A		L.A.G. # SK081672	



ID	OD	TEETH	THICK
35MM	53MM	70	0.5MM
MBO #2.0.5591.060		L.A.G. # SK081369	



ID	OD	TEETH	THICK
35MM	49MM	72TPI	0.8MM
MBO # N/A		L.A.G. # SK081673	

**30mm
SHAFT**



ID	OD	TEETH	THICK
35MM	50MM	72TPI	0.8MM
MBO # N/A		L.A.G. # SK081674	



ID	OD	TEETH	THICK
35MM	53MM	82	0.5MM
MBO #2.0.5591.082		L.A.G. # SK081676	

Not Pictured

ID	OD	TEETH	THICK
35MM	52MM	72TPI	0.8MM
MBO # N/A		L.A.G. # SK081675	

**30mm
SHAFT**



ID	OD	TEETH	THICK
35MM	53MM	82	0.8MM
MBO # N/A		L.A.G. # SK081677	

**35mm
SHAFT**



ID	OD	TEETH	THICK
40MM	62MM	5	0.5MM
MBO # N/A		L.A.G. # SK081678	



ID	OD	TEETH	THICK
40MM	62MM	6	0.5MM
MBO # N/A		L.A.G. # SK081679	

TO ORDER:

PHONE. 818-846-9134

FAX. 818-846-2090

EMAIL. SALES@LAGRINDING.COM

MBO* Perforators - 35mm SHAFT



ID	OD	TEETH	THICK
40MM	61.5MM	8	0.5MM
MBO # 50210040		L.A.G. # SK081384	



ID	OD	TEETH	THICK
40MM	61.5MM	8	0.5MM
MBO # N/A		L.A.G. # SK081865	



ID	OD	TEETH	THICK
40MM	61.5MM	8V	0.5MM
MBO # N/A		L.A.G. # SK081658	



ID	OD	TEETH	THICK
40MM	62MM	10	0.5MM
MBO # 50210450		L.A.G. # SK081659	



ID	OD	TEETH	THICK
40MM	62MM	10	0.5MM
MBO # 60210260		L.A.G. # SK081660	



ID	OD	TEETH	THICK
40MM	61.5MM	12	0.5MM
MBO # 50210050		L.A.G. # SK081661	



ID	OD	TEETH	THICK
40MM	61.5MM	12V	0.5MM
MBO # 50210410		L.A.G. # SK081385	



ID	OD	TEETH	THICK
40MM	62MM	12	0.5MM
MBO # N/A		L.A.G. # SK081662	



ID	OD	TEETH	THICK
40MM	61.5MM	12	0.5MM
MBO # N/A		L.A.G. # SK081663	



ID	OD	TEETH	THICK
40MM	62MM	12	1.2MM
MBO # 60210280		L.A.G. # SK081664	



ID	OD	TEETH	THICK
40MM	64MM	12	0.5MM
MBO # N/A		L.A.G. # SK081665	



ID	OD	TEETH	THICK
40MM	64MM	12	0.9MM
MBO # 60210300		L.A.G. # SK081666	



ID	OD	TEETH	THICK
40MM	64MM	12	1.2MM
MBO # N/A		L.A.G. # SK081667	



ID	OD	TEETH	THICK
40MM	64MM	12	1.2MM
MBO # N/A		L.A.G. # SK081634	



ID	OD	TEETH	THICK
40MM	61.5MM	14	0.5MM
MBO # 50210460		L.A.G. # SK081633	

TO ORDER:

PHONE. 818-846-9134

FAX: 818-846-2090

EMAIL: SALES@LAGRINDING.COM

MBO* Perforators - 35mm SHAFT



ID	OD	TEETH	THICK
40MM	61.5MM	15	0.5MM
MBO # 50211160		L.A.G. # SK081680	



ID	OD	TEETH	THICK
40MM	61.5MM	15	0.5MM
MBO # N/A		L.A.G. # SK081681	



ID	OD	TEETH	THICK
40MM	61.5MM	16	0.5MM
MBO # 50210970		L.A.G. # SK081387	



ID	OD	TEETH	THICK
40MM	62MM	16	0.5MM
MBO # 50211630		L.A.G. # SK081682	



ID	OD	TEETH	THICK
40MM	60MM	18	0.5MM
MBO # 50210390		L.A.G. # SK081377	



ID	OD	TEETH	THICK
40MM	61.5MM	18	0.5MM
MBO # 50210060		L.A.G. # SK081683	



ID	OD	TEETH	THICK
40MM	61.5MM	18	0.5MM
MBO # 50210420		L.A.G. # SK081684	



ID	OD	TEETH	THICK
40MM	61.5MM	18	0.5MM
MBO # N/A		L.A.G. # SK081685	



ID	OD	TEETH	THICK
40MM	62MM	18	0.5MM
MBO # N/A		L.A.G. # SK081686	



ID	OD	TEETH	THICK
40MM	64MM	18	0.5MM
MBO # N/A		L.A.G. # SK081687	



ID	OD	TEETH	THICK
40MM	62MM	18V	0.5MM
MBO # N/A		L.A.G. # SK081688	



ID	OD	TEETH	THICK
40MM	60MM	28	0.5MM
MBO # 50210210		L.A.G. # SK081689	



ID	OD	TEETH	THICK
40MM	61.5MM	28	0.5MM
MBO # 50210070		L.A.G. # SK081388	



ID	OD	TEETH	THICK
40MM	62MM	30	0.5MM
MBO # N/A		L.A.G. # SK081690	



ID	OD	TEETH	THICK
40MM	64MM	30	0.5MM
MBO # N/A		L.A.G. # SK081691	

TO ORDER:

PHONE. 818-846-9134

FAX. 818-846-2090

EMAIL. SALES@LAGRINDING.COM

MBO* Perforators - 35mm SHAFT



ID	OD	TEETH	THICK
40MM	62MM	30V	0.5MM
MBO # N/A		L.A.G.#SK081692	



ID	OD	TEETH	THICK
40MM	61.5MM	32V	0.5MM
MBO # N/A		L.A.G.#SK081693	



ID	OD	TEETH	THICK
40MM	60MM	36	0.5MM
MBO # 50210720		L.A.G.#SK081378	



ID	OD	TEETH	THICK
40MM	62MM	40	0.5MM
MBO # N/A		L.A.G.#SK081694	



ID	OD	TEETH	THICK
40MM	61.5MM	45	0.5MM
MBO # N/A		L.A.G.#SK081695	



ID	OD	TEETH	THICK
40MM	60MM	48	0.5MM
MBO # 50210240		L.A.G.#SK081379	



ID	OD	TEETH	THICK
40MM	61.5MM	60V	0.5MM
MBO # N/A		L.A.G.#SK081697	



ID	OD	TEETH	THICK
40MM	60MM	12	0.5MM
MBO # N/A		L.A.G.#SK081696	

Not Pictured

ID	OD	TEETH	THICK
40MM	62MM	50TPI	1MM
MBO # N/A		L.A.G.#SK081390	



ID	OD	TEETH	THICK
40MM	62MM	60	0.5MM
MBO # N/A		L.A.G.#SK081698	



ID	OD	TEETH	THICK
40MM	62MM	72TPI	0.5MM
MBO # N/A		L.A.G.#SK081699	



ID	OD	TEETH	THICK
40MM	60MM	80	0.5MM
MBO # 50210230		L.A.G.#SK081380	



ID	OD	TEETH	THICK
40MM	62MM	80	0.5MM
MBO # N/A		L.A.G.#SK081700	



ID	OD	TEETH	THICK
40MM	59MM	80V	0.5MM
MBO # N/A		L.A.G.#SK081701	



ID	OD	TEETH	THICK
40MM	60MM	80V	0.5MM
MBO # N/A		L.A.G.#SK081702	

TO ORDER:

MBO* Perforators - 35/40/65mm SHAFT

**35mm
SHAFT**



ID	OD	TEETH	THICK
40MM	60MM	100	0.5MM
MBO #N/A		L.A.G.#SK081703	



ID	OD	TEETH	THICK
40MM	61.5MM	100	0.5MM
MBO #N/A		L.A.G.#SK081383	



ID	OD	TEETH	THICK
40MM	60MM	124	
MBO #N/A		L.A.G.#SK081656	

**40mm
SHAFT**



ID	OD	TEETH	THICK
45MM	61.5MM	8	0.5MM
MBO #N/A		L.A.G.#SK081704	



ID	OD	TEETH	THICK
45MM	62MM	18	0.5MM
MBO #50210190		L.A.G.#SK081859	



ID	OD	TEETH	THICK
45MM	61MM	28	0.5MM
MBO #50210370		L.A.G.#SK081705	

**40mm
SHAFT**



ID	OD	TEETH	THICK
45MM	60MM	48	0.5MM
MBO #50210380		L.A.G.#SK081706	

**65mm
SHAFT**



ID	OD	TEETH	THICK
70MM	100MM	13	0.5MM
MBO #N/A		L.A.G.#SK081707	



ID	OD	TEETH	THICK
70MM	100MM	13	0.5MM
MBO #N/A		L.A.G.#SK081708	

**65mm
SHAFT**



ID	OD	TEETH	THICK
70MM	100MM	18	0.5MM
MBO #50210341		L.A.G.#SK081710	



ID	OD	TEETH	THICK
70MM	100MM	24	0.5MM
MBO #50211130		L.A.G.#SK081711	

TO ORDER:

PHONE. 818-846-9134

FAX. 818-846-2090

EMAIL. SALES@LAGRINDING.COM

MBO* Slitters & Scores - 30/35mm SHAFT

**30mm
SHAFT**



ID	OD	TEETH	THICK
35MM	50.8MM		0.8MM
SCORE			
MBO #2.0.5591.080		L.A.G.# SK081712	



ID	OD	TEETH	THICK
35MM	52MM		0.8MM
SCORE			
MBO #2.0.5591.020		L.A.G.# SK081365	



ID	OD	TEETH	THICK
35MM	52MM		0.8MM
SLITTER			
MBO #N/A		L.A.G.# SK081366	

**30mm
SHAFT**



ID	OD	TEETH	THICK
35MM	53.5MM		0.5MM
SLITTER			
MBO #N/A		L.A.G.# SK081713	



ID	OD	TEETH	THICK
35MM	54MM		0.5MM
SPLIT SLITTER			
MBO #2.0.5591.090		L.A.G.# SK081721	



ID	OD	TEETH	THICK
35MM	54MM		0.8MM
SLITTER			
MBO #2.0.5591.010		L.A.G.# SK081370	

**30mm
SHAFT**



ID	OD	TEETH	THICK
35MM	55MM		0.8MM
SLITTER			
MBO #N/A		L.A.G.# SK081714	



ID	OD	TEETH	THICK
40MM	59MM		0.8MM
SPLIT SCORE			
MBO #50210550		L.A.G.# SK081715	



ID	OD	TEETH	THICK
40MM	59.5MM		0.8MM
SPLIT SCORE			
MBO #50210020		L.A.G.# SK081376	

**35mm
SHAFT**



ID	OD	TEETH	THICK
40MM	60MM		0.8MM
SPLIT SCORE			
MBO #50210220		L.A.G.# SK081716	



ID	OD	TEETH	THICK
40MM	60MM		1.0MM
SLITTER			
MBO #N/A		L.A.G.# SK081717	



ID	OD	TEETH	THICK
40MM	60MM		1.5MM
SCORE			
MBO #N/A		L.A.G.# SK081718	

**35mm
SHAFT**



ID	OD	TEETH	THICK
40MM	61MM		0.8MM
SPLIT SLITTER			
MBO #N/A		L.A.G.# SK081719	



ID	OD	TEETH	THICK
40MM	61.5MM		0.5MM
SLITTER			
MBO #50210260		L.A.G.# SK081382	



ID	OD	TEETH	THICK
40MM	61.5MM		1.0MM
SLITTER			
MBO #50210760		L.A.G.# SK081720	

TO ORDER:

PHONE. 818-846-9134

FAX: 818-846-2090

EMAIL. SALES@LAGRINDING.COM

MBO* Slitters & Scores - 35/40/65mm SHAFT

**35mm
SHAFT**



ID	OD	TEETH	THICK
40MM	61.5MM		1.5MM
SCORE			
MBO # 50210860		L.A.G.# SK081722	



ID	OD	TEETH	THICK
40MM	62MM		0.5MM
SLITTER			
MBO # 50210030		L.A.G.# SK081723	



ID	OD	TEETH	THICK
40MM	62MM		2.0MM
SLITTER			
MBO # 5021050		L.A.G.# SK081724	

**35mm
SHAFT**



ID	OD	TEETH	THICK
40MM	62MM		3.0MM
SLITTER			
MBO # N/A		L.A.G.# SK081725	



ID	OD	TEETH	THICK
40MM	64MM		0.5MM
SPLIT SLITTER			
MBO # 50210480		L.A.G.# SK081726	



ID	OD	TEETH	THICK
40MM	64MM		2.0MM
SLITTER			
MBO # N/A		L.A.G.# SK081727	

**40mm
SHAFT**



ID	OD	TEETH	THICK
45MM	61.5MM		0.5MM
SPLIT SLITTER			
MBO # 50210150		L.A.G.# SK081728	



ID	OD	TEETH	THICK
45MM	61.5MM		0.5MM
SPLIT SCORE			
MBO # N/A		L.A.G.# SK081729	



ID	OD	TEETH	THICK
40MM	61.5MM		0.5MM
SLITTER			
MBO # 50210780		L.A.G.# SK081730	

**65mm
SHAFT**

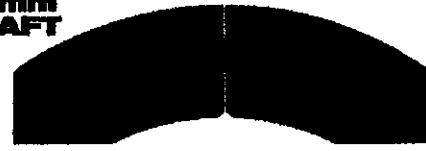

ID	OD	TEETH	THICK
70MM	100MM		0.5MM
SPLIT SLITTER			
MBO # 50210331		L.A.G.# SK081393	

TO ORDER:

PHONE. 818-846-9134

FAX. 818-846-2090

EMAIL. SALES@LAGRINDING.COM

STAHL* Perforators - 20/25mm SHAFT

**20mm
SHAFT**



ID	OD	TEETH	THICK
26MM	39MM	10	0.5MM
STAHL #200-750-06-00		L.A.G. #SK081766	



ID	OD	TEETH	THICK
26MM	39MM	15	0.5MM
STAHL #200-750-05-00		L.A.G. #SK081487	



ID	OD	TEETH	THICK
26MM	37.5MM	40	0.5MM
STAHL #217-636-01-00		L.A.G. #SK081767	

**20mm
SHAFT**

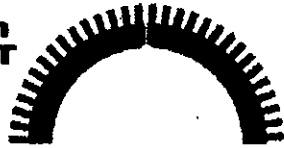

ID	OD	TEETH	THICK
26MM	37.5MM	60	0.5MM
STAHL #217-636-02-00		L.A.G. #SK081486	

**25mm
SHAFT**



ID	OD	TEETH	THICK
30MM	44.5MM	8	0.5MM
STAHL #200-771-02-00		L.A.G. #SK081768	



ID	OD	TEETH	THICK
30MM	48MM	9	0.5MM
STAHL #200-761-01-00		L.A.G. #SK081769	

**25mm
SHAFT**



ID	OD	TEETH	THICK
30MM	48MM	10	0.5MM
STAHL #200-750-02-00		L.A.G. #SK081497	



ID	OD	TEETH	THICK
30MM	48MM	10	0.5MM
STAHL #200-766-01-00		L.A.G. #SK081770	



ID	OD	TEETH	THICK
30MM	50.5MM	10	1.2MM
STAHL #213-038-01-00		L.A.G. #SK081771	

**25mm
SHAFT**



ID	OD	TEETH	THICK
30MM	48MM	12	0.5MM
STAHL #205-485-01-00		L.A.G. #SK081772	



ID	OD	TEETH	THICK
30MM	48MM	12	0.5MM
STAHL #200-759-05-00		L.A.G. #SK081498	



ID	OD	TEETH	THICK
30MM	45.5MM	15	0.5MM
STAHL #200-750-03-00		L.A.G. #SK081773	

**25mm
SHAFT**



ID	OD	TEETH	THICK
30MM	48MM	15	0.5MM
STAHL #205-908-02-00		L.A.G. #SK081499	



ID	OD	TEETH	THICK
30MM	48MM	15	0.5MM
STAHL #200-766-03-00		L.A.G. #SK081774	



ID	OD	TEETH	THICK
30MM	48MM	15	0.5MM
STAHL # N/A		L.A.G. #SK081775	

TO ORDER:

STAHL* Perforators - 25/35mm SHAFT

**25mm
SHAFT**



ID	OD	TEETH	THICK
30MM	48MM	18	0.5MM
STAHL#200-759-03-00		L.A.G.#SK081777	



ID	OD	TEETH	THICK
30MM	47MM	20	2MM
STAHL#213-201-01-00		L.A.G.#SK081776	



ID	OD	TEETH	THICK
30MM	48MM	24	0.5MM
STAHL#205-990-01-00		L.A.G.#SK081765	

**25mm
SHAFT**



ID	OD	TEETH	THICK
30MM	48MM	30	0.5MM
STAHL#200-758-02-00		L.A.G.#SK081500	



ID	OD	TEETH	THICK
30MM	45.5MM	40	0.5MM
STAHL#200-758-03-00		L.A.G.#SK081778	



ID	OD	TEETH	THICK
30MM	48MM	40	0.5MM
STAHL#200-758-04-00		L.A.G.#SK081501	

**25mm
SHAFT**



ID	OD	TEETH	THICK
30MM	45.5MM	50	0.5MM
STAHL#N/A		L.A.G.#SK081779	



ID	OD	TEETH	THICK
30MM	45.5MM	60	0.5MM
STAHL#200-758-05-00		L.A.G.#SK081780	



ID	OD	TEETH	THICK
30MM	48MM	60	0.5MM
STAHL#200-758-06-00		L.A.G.#SK081502	

**25mm
SHAFT**



ID	OD	TEETH	THICK
30MM	45.5MM	72V	0.5MM
STAHL#N/A		L.A.G.#SK081493	



ID	OD	TEETH	THICK
30MM	48MM	72	0.5MM
STAHL#200-759-06-00		L.A.G.#SK081781	

**35mm
SHAFT**



ID	OD	TEETH	THICK
40MM	62MM	5	0.5MM
STAHL#200-769-02-00		L.A.G.#SK081782	

**35mm
SHAFT**



ID	OD	TEETH	THICK
40MM	62MM	6	0.5MM
STAHL#200-756-07-00		L.A.G.#SK081519	



ID	OD	TEETH	THICK
40MM	62MM	6V	0.5MM
STAHL#N/A		L.A.G.#SK081783	



ID	OD	TEETH	THICK
40MM	61.5MM	8	0.5MM
STAHL#N/A		L.A.G.#SK081784	

TO ORDER:

PHONE. 818-846-9134

FAX. 818-846-2090

EMAIL. SALES@LAGRINDING.COM

STAHL* Perforators - 35mm SHAFT



ID	OD	TEETH	THICK
40MM	61.5MM	8	0.5MM
STAHL# N/A		L.A.G.#SK081514	



ID	OD	TEETH	THICK
40MM	61MM	8	0.5MM
STAHL#200-756-08-00		L.A.G.#SK081785	



ID	OD	TEETH	THICK
40MM	62MM	10	0.5MM
STAHL# N/A		L.A.G.#SK081786	



ID	OD	TEETH	THICK
40MM	62MM	10	0.5MM
STAHL# N/A		L.A.G.#SK081787	



ID	OD	TEETH	THICK
40MM	62MM	12	0.5MM
STAHL#200-749-01-00		L.A.G.#SK081789	



ID	OD	TEETH	THICK
40MM	62MM	12	0.5MM
STAHL# 205-97801-00		L.A.G.#SK081788	



ID	OD	TEETH	THICK
40MM	62MM	12	0.5MM
STAHL# N/A		L.A.G.#SK081521	



ID	OD	TEETH	THICK
40MM	62MM	12	1.2MM
STAHL# N/A		L.A.G.#SK081790	



ID	OD	TEETH	THICK
40MM	64MM	12	1.2MM
STAHL#213-028-01-00		L.A.G.#SK081791	



ID	OD	TEETH	THICK
40MM	64MM	12	0.9MM
STAHL#213-027-01-00		L.A.G.#SK081792	



ID	OD	TEETH	THICK
40MM	64MM	12	1.2MM
STAHL# N/A		L.A.G.#SK081793	



ID	OD	TEETH	THICK
40MM	64MM	12	1.2MM
STAHL#213-028-01-00		L.A.G.#SK081794	



ID	OD	TEETH	THICK
40MM	62MM	12V	0.5MM
STAHL#226-350-01-00		L.A.G.#SK081795	



ID	OD	TEETH	THICK
40MM	62MM	15	0.5MM
STAHL#200-756-09-00		L.A.G.#SK081522	



ID	OD	TEETH	THICK
40MM	62MM	15	0.5MM
STAHL#200-769-01-00		L.A.G.#SK081796	

TO ORDER:

STAHL* Perforators - 35mm SHAFT



ID	OD	TEETH	THICK
40MM	62MM	16	0.5MM
STAHL# N/A		L.A.G.#SK081797	



ID	OD	TEETH	THICK
40MM	62MM	16	0.5MM
STAHL#N/A		L.A.G.#SK081798	



ID	OD	TEETH	THICK
40MM	60MM	18	0.5MM
STAHL# N/A		L.A.G.#SK081799	



ID	OD	TEETH	THICK
40MM	62MM	18	0.5MM
STAHL# 200-749-02-00		L.A.G.#SK081800	



ID	OD	TEETH	THICK
40MM	62MM	18	0.5MM
STAHL#200-765-01-00		L.A.G.#SK081801	



ID	OD	TEETH	THICK
40MM	62MM	18	0.5MM
STAHL#205-978-02-00		L.A.G.#SK081657	



ID	OD	TEETH	THICK
40MM	64MM	18	0.5MM
STAHL#N/A		L.A.G.#SK081802	



ID	OD	TEETH	THICK
40MM	62MM	18V	0.5MM
STAHL# 226-350-02-00		L.A.G.#SK081803	



ID	OD	TEETH	THICK
40MM	62MM	18V	0.5MM
STAHL# N/A		L.A.G.#SK081804	



ID	OD	TEETH	THICK
40MM	62MM	24	2MM
STAHL#273-918-01-00		L.A.G.#SK081805	



ID	OD	TEETH	THICK
40MM	60MM	28	0.5MM
STAHL#N/A		L.A.G.#SK081806	



ID	OD	TEETH	THICK
40MM	61.5MM	28	0.5MM
STAHL#210-621-01-00		L.A.G.#SK081807	



ID	OD	TEETH	THICK
40MM	62MM	30	0.5MM
STAHL#N/A		L.A.G.#SK081524	



ID	OD	TEETH	THICK
40MM	64MM	30	0.5MM
STAHL#N/A		L.A.G.#SK081809	



ID	OD	TEETH	THICK
40MM	62MM	30V	0.5MM
STAHL#200-756-01-00		L.A.G.#SK081517	

TO ORDER:

PHONE. 818-846-9134

FAX. 818-846-2090

EMAIL. SALES@LAGRINDING.COM

STAHL* Perforators - 35mm SHAFT



ID	OD	TEETH	THICK
40MM	62MM	32V	0.5MM
STAHL # 200-756-02-00		L.A.G. #SK081810	



ID	OD	TEETH	THICK
40MM	60MM	36	0.5MM
STAHL # 200-756-12-00		L.A.G. #SK081811	



ID	OD	TEETH	THICK
40MM	62MM	40	0.5MM
STAHL # 200-749-03-00		L.A.G. #SK081812	



ID	OD	TEETH	THICK
40MM	61.5MM	45	0.5MM
STAHL #200-756-0400		L.A.G. #SK081813	



ID	OD	TEETH	THICK
40MM	60MM	48	0.5MM
STAHL #N/A		L.A.G. #SK081814	



ID	OD	TEETH	THICK
40MM	60MM	60	0.5MM
STAHL # 200-754-06-00		L.A.G. #SK081815	



ID	OD	TEETH	THICK
40MM	60MM	60V	0.5MM
STAHL # 200-754-05-00		L.A.G. #SK081816	



ID	OD	TEETH	THICK
40MM	62MM	72TPI	1.0MM
STAHL # N/A		L.A.G. #SK081817	



ID	OD	TEETH	THICK
40MM	60MM	80	0.5MM
STAHL # 200-754-04-00		L.A.G. #SK081818	



ID	OD	TEETH	THICK
40MM	62MM	80	0.5MM
STAHL #N/A		L.A.G. #SK081825	



ID	OD	TEETH	THICK
40MM	59MM	80V	0.5MM
STAHL # 200-754-03-00		L.A.G. #SK081819	



ID	OD	TEETH	THICK
40MM	60MM	80	0.5MM
STAHL # N/A		L.A.G. #SK081820	



ID	OD	TEETH	THICK
40MM	60MM	100	0.5MM
STAHL #N/A		L.A.G. #SK081821	



ID	OD	TEETH	THICK
40MM	61.5MM	100	0.5MM
STAHL # N/A		L.A.G. #SK081822	



ID	OD	TEETH	THICK
40MM	60MM	124	0.5MM
STAHL #N/A		L.A.G. #SK081823	

TO ORDER:

PHONE. 818-846-9134

FAX. 818-846-2090

EMAIL. SALES@LAGRINDING.COM

STAHL* Perforators - 50mm SHAFT



ID	OD	TEETH	THICK
55MM	79MM	9	0.5MM
STAHL#200-748-04-00		L.A.G.#SK081824	



ID	OD	TEETH	THICK
55MM	81MM	16	0.9MM
STAHL#213-031-01-00		L.A.G.#SK081825	



ID	OD	TEETH	THICK
55MM	78.5MM	18	0.5MM
STAHL#205-981-02-00		L.A.G.#SK081826	



ID	OD	TEETH	THICK
55MM	79MM	18V	0.5MM
STAHL#226-349-01-00		L.A.G.#SK081827	



ID	OD	TEETH	THICK
55MM	78.5MM	30	0.5MM
STAHL#205-981-01-00		L.A.G.#SK081828	



ID	OD	TEETH	THICK
55MM	78.5MM	40	0.5MM
STAHL#200-748-03-00		L.A.G.#SK081829	



ID	OD	TEETH	THICK
55MM	78.5MM	70	0.5MM
STAHL#200-755-01-00		L.A.G.#SK081830	

TO ORDER:

PHONE. 818-846-9134

FAX. 818-846-2090

EMAIL. SALES@LAGRINDING.COM

STAHL* Slitters & Scores - 20/25/35mm SHAFT

**20mm
SHAFT**

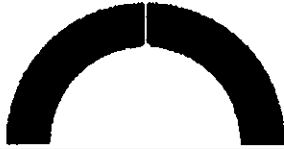

ID	OD	TEETH	THICK
26MM	37.5MM		0.8MM
SPLIT - SCORE			
STAHL #200-742-11-00		L.A.G. #SK081831	



ID	OD	TEETH	THICK
26MM	40MM		0.5MM
SPLIT - SLITTER			
STAHL #200-747-11-00		L.A.G. #SK081832	



ID	OD	TEETH	THICK
26MM	40MM		1.0MM
SLITTER			
STAHL #226-341-01-00		L.A.G. #SK081833	

**20mm
SHAFT**



ID	OD	TEETH	THICK
26MM	42MM		0.5MM
SPLIT - SLITTER			
STAHL # N/A		L.A.G. #SK081834	

**25mm
SHAFT**



ID	OD	TEETH	THICK
30MM	45MM	0.8MM	
SPLIT - SCORE			
STAHL #200-742-04-00		L.A.G. #SK081492	



ID	OD	TEETH	THICK
30MM	47.5MM		0.8MM
SPLIT - SCORE			
STAHL # N/A		L.A.G. #SK081835	

**25mm
SHAFT**



ID	OD	TEETH	THICK
30MM	47.5MM		1.5MM
SCORE			
STAHL #N/A		L.A.G. #SK081836	



ID	OD	TEETH	THICK
30MM	48MM	100	0.5MM
SPLIT - SLITTER			
STAHL #200-747-01-00		L.A.G. #SK081503	



ID	OD	TEETH	THICK
30MM	48MM		1.0MM
SLITTER			
STAHL #226-341-02-00		L.A.G. #SK081837	

**25mm
SHAFT**



ID	OD	TEETH	THICK
30MM	48MM		2.0MM
SLITTER			
STAHL #205-970-05-00		L.A.G. #SK081838	



ID	OD	TEETH	THICK
30MM	49MM		2.0MM
SLITTER			
STAHL # N/A		L.A.G. #SK081839	



ID	OD	TEETH	THICK
30MM	50MM		0.5MM
SPLIT - SLITTER			
STAHL # N/A		L.A.G. #SK081840	

**35mm
SHAFT**



ID	OD	TEETH	THICK
40MM	59MM		0.8MM
SPLIT - SCORE			
STAHL #200-742-12-00		L.A.G. #SK081841	



ID	OD	TEETH	THICK
40MM	59.5MM		
SPLIT - SCORE			
STAHL #200-742-09-00		L.A.G. #SK081842	



ID	OD	TEETH	THICK
40MM	60MM		0.8MM
SPLIT - SCORE			
STAHL #200-742-06-00		L.A.G. #SK081843	

TO ORDER:

PHONE. 818-846-9134

FAX. 818-846-2090

EMAIL. SALES@LAGRINDING.COM

STAHL* Slitters & Scores - 35/50mm SHAFT

**35mm
SHAFT**



ID	OD	TEETH	THICK
40MM	60MM		1.0MM
SLITTER			
STAHL # N/A		L.A.G. #SK081844	



ID	OD	TEETH	THICK
40MM	60MM		1.5MM
SCORE			
STAHL #200-753-01-00		L.A.G. #SK081845	



ID	OD	TEETH	THICK
40MM	61MM		0.8MM
SPLIT-SCORE			
STAHL #200-742-05-00		L.A.G. #SK081512	

**35mm
SHAFT**



ID	OD	TEETH	THICK
40MM	62MM		0.5MM
SPLIT- SLITTER			
STAHL #200-747-03-00		L.A.G. #SK081846	



ID	OD	TEETH	THICK
40MM	61.5MM		0.5MM
SLITTER			
STAHL # N/A		L.A.G. #SK081847	



ID	OD	TEETH	THICK
40MM	61.5MM		1.0MM
SLITTER			
STAHL #226-341-03-00		L.A.G. #SK081848	

**35mm
SHAFT**



ID	OD	TEETH	THICK
40MM	61.5MM		1.5MM
SCORE			
STAHL # N/A		L.A.G. #SK081849	



ID	OD	TEETH	THICK
40MM	62MM		2.0MM
SLITTER			
STAHL #205-970-01-00		L.A.G. #SK081527	



ID	OD	TEETH	THICK
40MM	64MM		0.5MM
SPLIT- SLITTER			
STAHL #200-474-05-00		L.A.G. #SK081850	

**35mm
SHAFT**



ID	OD	TEETH	THICK
40MM	64MM		1.0MM
SPLIT- SLITTER			
STAHL # N/A		L.A.G. #SK081851	



ID	OD	TEETH	THICK
40MM	64MM		2.0MM
SLITTER			
STAHL #205-970-02-00		L.A.G. #SK081852	

**50mm
SHAFT**



ID	OD	TEETH	THICK
55MM	77MM		0.5MM
SPLIT-SCORE			
STAHL #200-742-08-00		L.A.G. #SK081853	

**50mm
SHAFT**



ID	OD	TEETH	THICK
55MM	78.5MM		0.5MM
SPLIT- SLITTER			
STAHL #200-747-07-00		L.A.G. #SK081854	



ID	OD	TEETH	THICK
55MM	79MM		2.0MM
SLITTER			
STAHL #205-972-01-00		L.A.G. #SK081855	

TO ORDER:

PHONE. 818-846-9134

FAX. 818-846-2090

EMAIL: SALES@LAGRINDING.COM

